

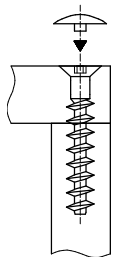

" - "

" - 1"

2050 3000 544

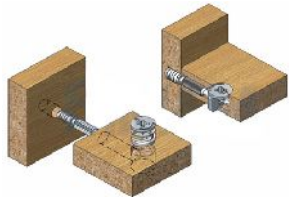
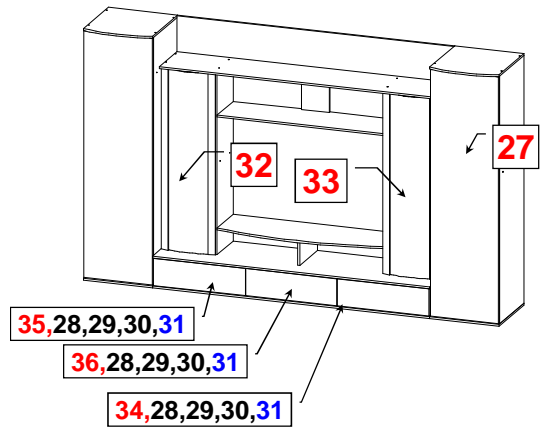

7 \* 50

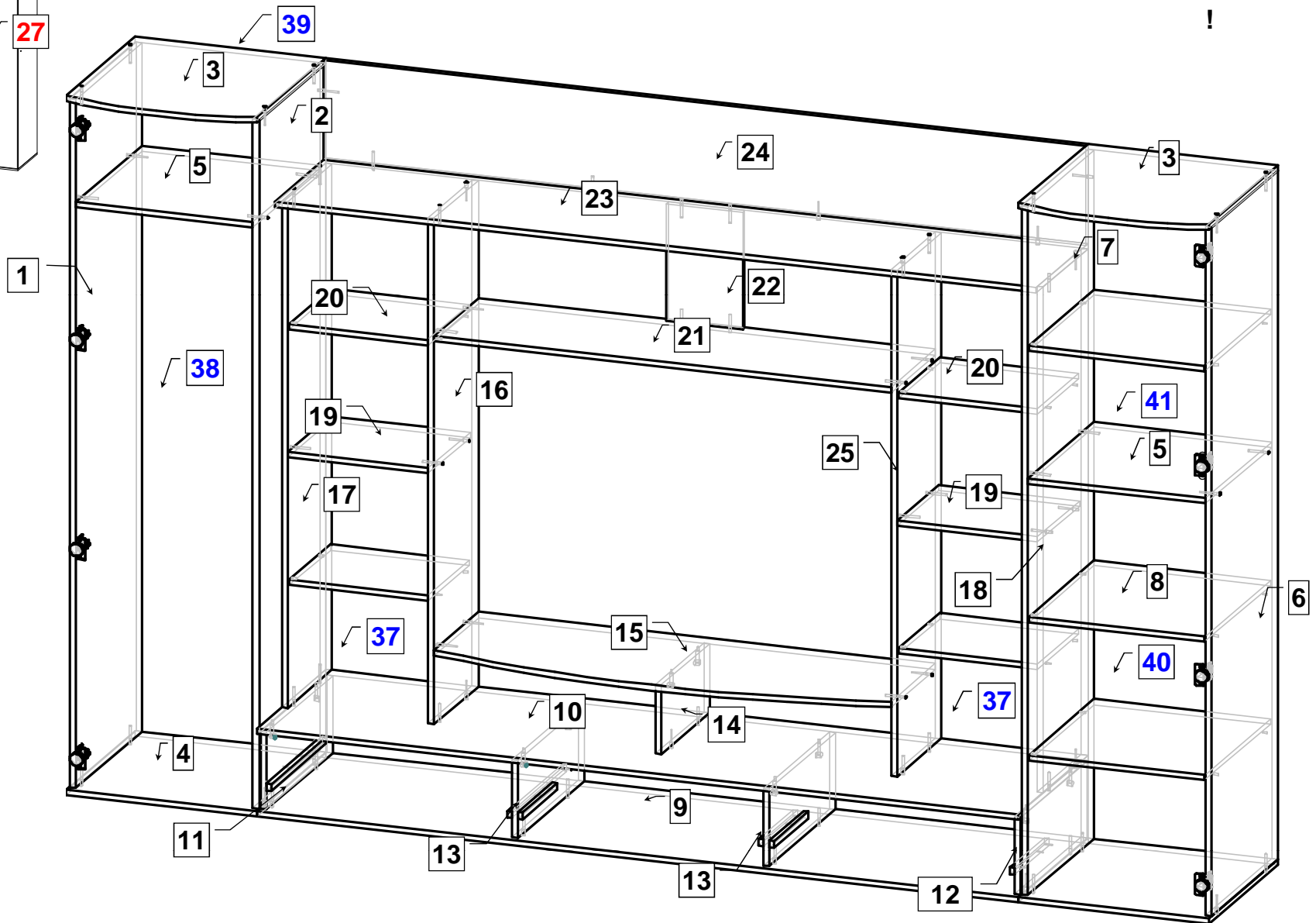







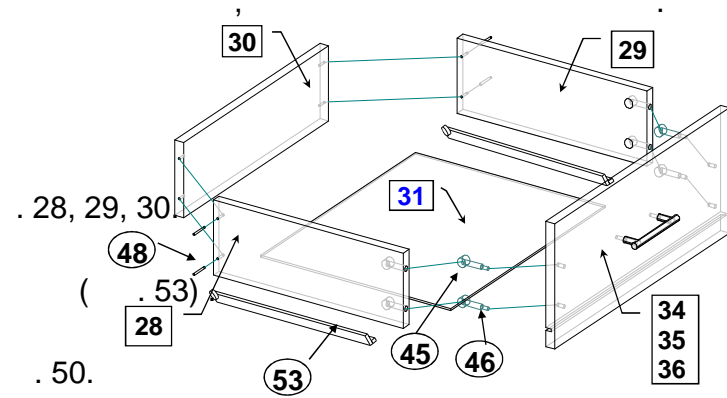









\*\*\*

1	.21.61.00.01.00		1998 x 480	1	16,0	3/6
2	.21.61.00.02.00		1998 x 480	1	16,0	3/6
3	.21.61.00.03.00		500 x 540	2	16,0	2/6
4	.21.61.00.04.00		500 x 500	2	16,0	2/6
5	.21.61.00.05.00		466 x 478	2	16,0	3/6
6	.21.61.00.06.00		1998 x 480	1	16,0	2/6
7	.21.61.00.07.00		1998 x 480	1	16,0	1/6
8	.21.61.00.08.00		462 x 474	3	16,0	2/6
9	.21.61.00.09.00		2000 x 500	1	16,0	2/6
10	.21.61.00.10.00		2000 x 500	1	16,0	2/6
11	.21.61.00.11.00		224 x 480	1	16,0	3/6
12	.21.61.00.12.00		224 x 480	1	16,0	3/6
13	.21.61.00.13.00		224 x 480	2	16,0	2/6
14	.21.61.00.14.00		200 x 350	1	16,0	4/6
15	.21.61.00.15.00		1200 x 400	1	16,0	3/6
16	.21.61.00.16.00		1468 x 320	1	16,0	4/6
17	.21.61.00.17.00		1468 x 320	1	16,0	4/6
18	.21.61.00.18.00		1468 x 320	1	16,0	4/6
19	.21.61.00.19.00		366 x 318	2	16,0	4/6
20	.21.61.00.20.00		362 x 314	4	16,0	4/6
21	.21.61.00.21.00		1200 x 318	1	16,0	4/6
22	.21.61.00.22.00		340 x 200	1	16,0	4/6
23	.21.61.00.23.00		2000 x 370	1	16,0	3/6
24	.21.61.00.24.00		2000 x 290	1	16,0	1/6
25	.21.61.00.25.00		1468 x 320	1	16,0	4/6
26	.21.61.00.26.00		1990 x 494	1	/	1/6
27	.21.61.00.27.00		1990 x 494	1	/	1/6
28	.21.61.00.28.00		400 x 120	3	16,0	3/6
29	.21.61.00.29.00		400 x 120	3	16,0	3/6
30	.21.61.00.30.00		588 x 120	3	16,0	3/6
31	.21.61.00.31.00		615 x 408	3	4,0	3/6
32	.21.61.00.32.00		1460 x 392	1	/	5/6
33	.21.61.00.33.00		1460 x 392	1	/	5/6
34	.21.61.00.34.00		662 x 218	1	/	1/6
35	.21.61.00.35.00		662 x 218	1	/	1/6
36	.21.61.00.36.00		662 x 218	1	/	1/6
37	.21.61.00.37.00		1495 x 396	2	4,0	1/6
38	.21.61.00.38.00		1705 x 496	1	4,0	1/6
39	.21.61.00.39.00		320 x 496	1	4,0	1/6
40	.21.61.00.40.00		1215 x 496	1	4,0	1/6
41	.21.61.00.41.00		810 x 496	1	4,0	1/6

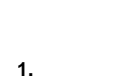
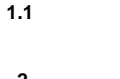
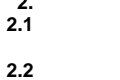
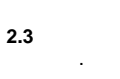
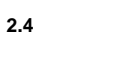
	4 25 ( . 62),	.54	.4, 9.
. 1, 6, 17, 18	4 16 ( . 61)		3,5 16 ( . 60)
	. 11, 12, 13		( . 53)
	7 50 ( . 48)	.19	.15
25,	. 16, 25,		.21
	. 11, 12, 13	.9.	. 16, 17, 18
	. 14, 16, 17, 18, 25	.10.	( . 45, 46)
	. 14	.15,	. 11, 12, 13
. 10.	7 50 ( . 48)	. 16, 17, 18, 22, 25	.23
.3,	.4, 5	. 1, 2, 6, 7.	
.24	7 50 ( . 48)	.23	
. 2, 7.	. 37, 38, 39, 40, 41		3 16
( . 59),	.52.		. 1, 2
3,5 16 ( . 60)	.56	.64.	
	!		
1.	7 50 ( . 48)	.28, 29, 30.	
2.	( . 45, 46)	.28, 29.	
.34 (35, 36)		.31	
3.	.51	3 * 16 ( . 59)	
4.	.28, 29	.31,	
3,5 * 16 ( . 60)			
4 16 ( . 61)	.26, 27, 32, 33		
	.26, 27, 32, 33.		
.57.	.47, 58,		
.55.	5,0	.6, 7	
.56.	.8.		



	45	16
	46	DU 232 . Ø 5 . 16
	47	16
	48	7 50 82
	49	1
	50	0 14
	51	9
	52	( ) 14
	53	L=400 . 3
	54	13
	55	14
	56	28
	57	7
	58	30
	59	3 * 16 200
	60	3,5 * 16 38
	61	4 * 16 64
	62	4 * 25 26
	63	2
	64	L=460 . 1

- 1.
- 1.1
- 2.
- 2.1
- 2.2
- 2.3
- 2.4

+5 40 .

+40 .

16371-2014« . »

025/2012 " " , ,

24

( ) .

025/2012, 16371-2014

---



---

( )

10 .

:

, 27.



606 400

WEB- : www.olmeko.ru / 8(83144) 66-777